

Preface

Thank you for purchasing the new UTi712S thermal imager. In order to use this product safely and correctly, please read this manual thoroughly, especially the *Safety Instructions* part.

After reading this manual, it is recommended to keep the manual at an easily accessible place, preferably close to the device, for future reference.

Limited Warranty and Liability

Uni-Trend guarantees that the product is free from any defect in material and workmanship within one year from the purchase date. This warranty does not apply to damages caused by accident, negligence, misuse, modification, contamination or improper handling. The dealer shall not be entitled to give any other warranty on behalf of Uni-Trend. If you need warranty service within the warranty period, please contact your seller directly.

Uni-Trend will not be responsible for any special, indirect, incidental or subsequent damage or loss caused by using this device.

Table of Contents

1. Specifications -----	4
2. Structure -----	6
3. LCD Indicators/Icons -----	7
4. Power on/off -----	7
5. Menu -----	8
6. Image View -----	8
7. Temperature Mark -----	9
8. HI/LO Alert -----	9
9. LED light -----	10
10. Palette -----	10
11. Language -----	11
12. Temperature Unit -----	11
13. Measured Parameters -----	12
14. Laser -----	12
15. Time & Date -----	13
16. Brightness -----	13
17. Auto Power Off -----	14
18. Auto Save -----	14
19. Format SD -----	15
20. Device Info -----	15
21. Factory Reset -----	16
22. USB Communication and PC Analysis Software -----	16
23. Maintenance -----	16
24. Safety Instructions -----	17
25. Appendix -----	17

1. Specifications

Sensor	Uncooled infrared focal plane thermal imaging sensor
Pixel size	17 μ m
Infrared spectrum bandwidth	8~14 μ m
Thermal imaging pixels	10800 (120*90)
Thermal imaging sensitivity	<60mK
Field of view (FOV)	50°(H) x 38°(V)
Spatial resolution (IFOV)	7.6 mrad
Rate	25Hz
Minimum imaging distance	0.1m
Focus	Focus-free
Temperature range	-20°C ~ 400°C
Accuracy	$\pm 2^{\circ}\text{C}$ or $\pm 2\%$, whichever is greater (-10°C ~ 400°C room temperature 25°C)
Measurement units	°C/°F
Resolution	0.1°C
Emissivity	0.95 (default) 0.01 ~ 0.99
Temperature display	Center point temperature, high/low temperature tracking
Palettes	lava , rainbow HC , black hot , white hot, iron, Rainbow
Display type	2.4" TFT LCD
Display resolution	320 x 240

Buttons	4 buttons (power, up, down, OK) 1 trigger
Laser	√(Class 2)
LED Light	√
Temperature alarms	LCD, LED, buzzer
Image storage	Micro SD Card
Image format	BMP
PC analysis software	√
USB communication	Type-C USB
Battery	Li-ion 3.7V/2600mAh 18650
Operating time	Continuous operating time >9h
Charging time	≤2.5h
Charging voltage/current	5V / 2A
Power on speed	0s (wake up) / 5s (power on)
Auto power off	5min/10min/30min(default)/off
Operating temperature	0 ~ 50°C (32 ~ 140°F)
Storage temperature	-20 ~ 60°C (-4 ~ 140°F)
Operating humidity	< 85%RH (Operating humidity)
IP rating	IP54
Drop proof	2m
Product size (L×W×H)	197 x 72 x 60 mm
Product weight	310g
Certificates	CE 、 UKCA、 RoHS
Accessories	User manual, Type-C USB cable, 16GB Micro SD card

2. Structure

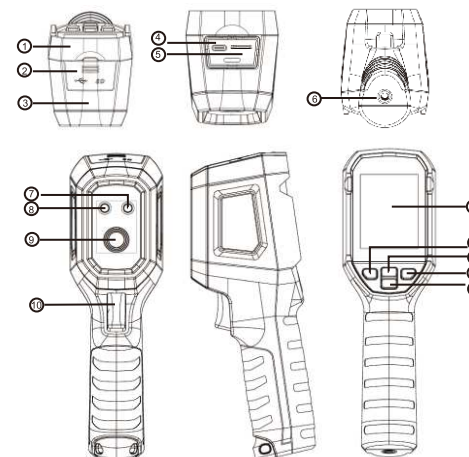

Item	Description	Item	Description
1	Upper housing	9	Infrared camera lens
2	Interface protection cover	10	Image capture/trigger
3	Lower housing	11	LCD
4	USB Type-C interface	12	OK
5	SD card slot	13	Up
6	Bracket screw hole	14	Power / Back
7	Laser emission aperture	15	Down
8	LED light		

3. LCD Indicators/Icons

Display size: 2.4" (495mm×377mm)

Display resolution: 320 (vertical) × 240 (horizontal)



Item	Description
1	Center point temperature
2	Center point
3	Lowest temperature spot
4	Date and time
5	Battery status
6	Temperature Bar
7	Highest temperature spot

4. Power On/Off

When the thermal imager is not turned on, long press the power button for 3s to power on. When the thermal imager is in the suspend state, short press the power button for 1s to power on.

When the thermal imager is turned on, short press the power button for 1s to enter the suspend state. Long press the power button for 8s, "power off" will show on the screen, and the thermal imager will be turned off.

5. Menu

Short press the OK button to enter the menu interface. Short press the Back button to return to the upper menu. Short press the trigger to directly return to the main interface of the thermal imager.

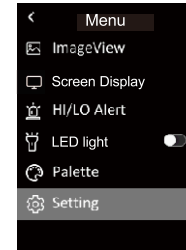

6. Image View

In the menu, select Image View, and then short press the OK button to enter the image viewing interface. Press the Up/Down button to select an image. Press the OK button twice to view the Picture Info or Delete images.

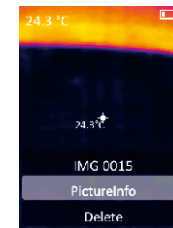

7. Temperature Mark

In the menu, short press the Up/Down button to select Temper Mark, and then short press the OK button to enter the temperature mark interface. Center Point/Hi/Lo Point/Palette/Date&Time can be set in this interface. For example, select Center Point, and then press the OK button to turn on/off this function.

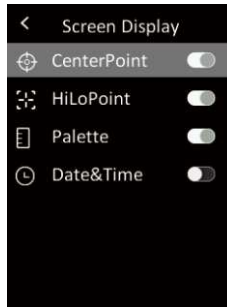

8. HI/LO Alert

In the menu, short press the Up/Down button to select HI/LO Alert, and then short press the OK button to enter the alert setting interface. Temper Alert, Buzzer, HI Alert and LO Alert can be set in this interface.

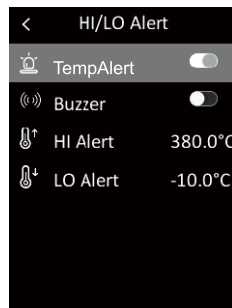

9. LED light

In the menu, short press the Up/Down button to select Hand Light, and then short press the OK button to turn on/off the flashlight.

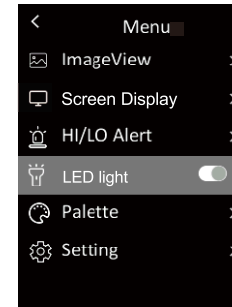

10. Palette

In the menu, short press the Up/Down button to select Palette, and then short press the OK button to enter the palette selection interface. Short press the Up/Down button to step through six palettes: Rainbow, Iron, White Hot, Black Hot, Rainbow HC, Lava, and short press the OK button to confirm the selected palette.

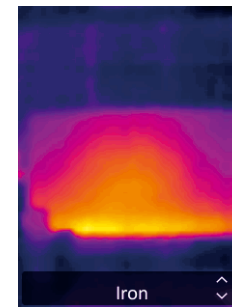

11. Language

In the menu, short press the Up/Down button to select Setting, and then short press the OK button to enter the submenu. Select Language, and short press the OK button to switch different Languages.

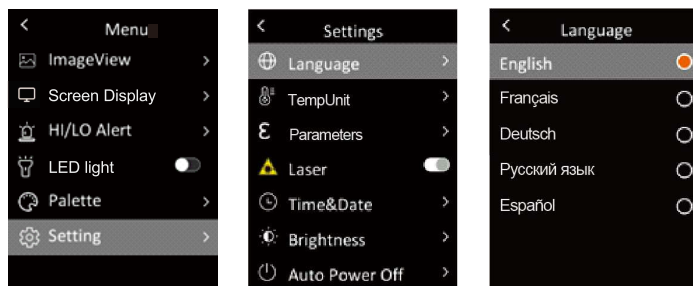

12. Temperature Unit

In the menu, short press the Up/Down button to select Setting, and then short press the OK button to enter the submenu. In the submenu, short press the Up/Down button to select Temper Unit, and short press the OK button to switch between °C/°F.

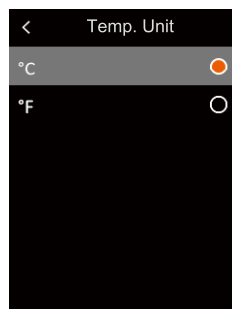

13. Measured Parameters

In the menu, short press the Up/Down button to select setting, and then short press the OK button to enter the submenu. In the submenu, short press the UP/Down button to select Emissivity or Temp.Comp, and short press the OK button for settings.

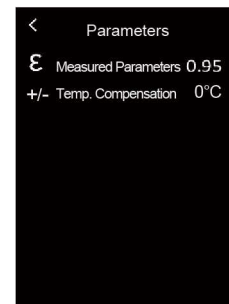

14. Laser

In the menu, short press the Up/Down button to select Setting, and then short press the OK button to enter the submenu. In the submenu, short press the Up/Down button to select Laser, and short press the OK button to turn on/off the laser.

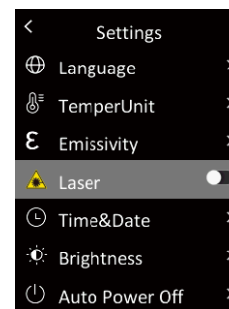

15. Time & Date

In the menu, short press the Up/Down button to select Setting, and then short press the OK button to enter the submenu. In the submenu, short press the Up/Down button to select Time&Date, and short press the OK button to enter the setting interface. The Time Format can switch between 12H and 24H. Press the Up/Down button to adjust the value of time and date, and short press the OK button to confirm.

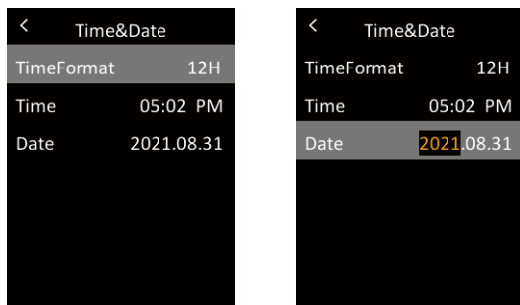

16. Brightness

In the menu, short press the Up/Down button to select Setting, and then short press the OK button to enter the submenu. In the submenu, short press the Up/Down button to select Brightness, and short press the OK button to enter the setting interface. The brightness can be Low, Middle or High.

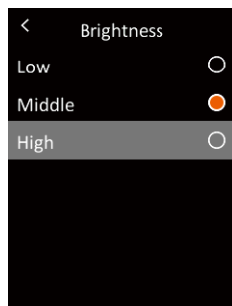

17. Auto Power Off

In the menu, short press the Up/Down button to select Setting, and then short press the OK button to enter the submenu. In the submenu, short press the Up/Down button to select Auto Power Off, and short press the OK button to enter the setting interface. In this interface, users can set the auto power off time (5/10/30min) or turn off the auto power off function.

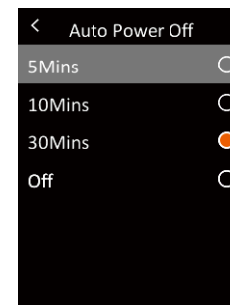

18. Auto Save

In the menu, short press the Up/Down button to select Setting, and then short press the OK button to enter the submenu. In the submenu, short press the Up/Down button to select Auto Save. Short press the OK button to turn on/off the auto save function.

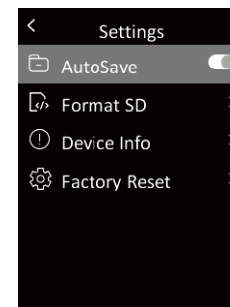

19. Format SD

In the menu, short press the Up/Down button to select Setting, and then short press the OK button to enter the submenu. In the submenu, short press the Up/Down button to select Format SD and short press the OK button to enter the setting interface. Press the OK button select Yes or No.

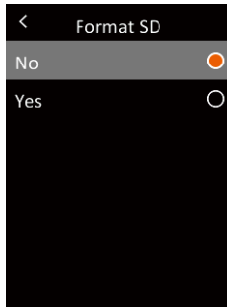

20. Device Info

In the menu, short press the Up/Down button to select Setting, and then short press the OK button to enter the submenu. In the submenu, short press the Up/Down button to select Device Info and short press the OK button to enter the information viewing interface. The device information including Code, Firmware, Capacity and Available can be viewed.

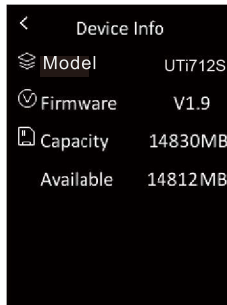

21. Factory Reset

In the menu, short press the Up/Down button to select Setting, and then short press the OK button to enter the submenu. In the submenu, short press the Up/Down button to select Factory Reset and short press the OK button to enter the setting interface. Press the OK button select Yes or No.



22. USB Communication and PC Analysis Software

1. Please refer to the instructions to download and install the PC software.
2. Connect the USB data cable to the computer. Users can view images and analyze data via the PC software.
3. To use the PC software correctly, please read the Software User Manual.
4. During USB communication, do not directly unplug the USB cable. If users want to disconnect the device when it has been successfully connected to the computer, they can select Remove Device in the lower right corner of the computer.

23. Maintenance

Use a wet cloth or weak soap solution to clean the outer shell of the device. Do not use abrasives, isopropyl alcohol or solvents to clean the outer shell, lens or window.

24. Safety Instructions

In order to ensure the measurement accuracy, please read the instructions carefully. Please use this product in accordance with the user manual. Otherwise the free warranty will not be carried out if the product is damaged. Please do not use this product in flammable, explosive, steamy, humid or corrosive environments. Please do not continue to use the product when it is damaged, dropped or corrected, so as to avoid erroneous measurement results. Please refer to the emissivity to get the actual temperature. Otherwise the measured temperature will be inaccurate. Charging will cause the internal temperature of the machine to rise, thereby affecting the measurement accuracy. Therefore, it is recommended not to take measurements when charging the product.

25. Appendix

Material	Emissivity	Material	Emissivity
Wood	0.85	Black paper	0.86
Water	0.96	Polycarbonate	0.8
Brick	0.75	Concrete	0.97
Stainless steel	0.14	Copper oxide	0.78
Adhesive tape	0.96	Cast iron	0.81
Aluminum plate	0.09	Rust	0.8
Copper plate	0.06	Gypsum	0.75
Black aluminum	0.95	Paint	0.9
Human skin	0.98	Rubber	0.95
Asphalt	0.96	Soil	0.93
PVC plastic	0.93		

UNI-T®

UNI-TREND TECHNOLOGY (CHINA) CO., LTD.

No. 6, Gong Ye Bei 1st Road,
Songshan Lake National High-Tech Industrial
Development Zone, Dongguan City,
Guangdong Province, China

